

MED (TRON<sup>®</sup>) AG  
GERMANY



# Essential for contrast

Accutron<sup>®</sup> Injectors for Computed Tomography

# Accutron® CT-D Vision

## Better Comfort and Safer Use

We enhanced Accutron® CT-D Vision's operability for a better comfort and safer use.

## IMPROVED READABILITY & LESS EYE FATIGUE



Radiographers and radiologists are working mostly on screens throughout the day, monitoring examinations and analysing images. With high resolution touch screens, of 10" on the injection unit and 12" on the remote control, Accutron® CT-D Vision improves the comfort of use and helps to reduce eye fatigue. The new graphical user interface provides a comprehensive overview of each examination.



Model CT860

## ENRICHED USER EXPERIENCE

The upgraded graphical user interface of Accutron® CT-D Vision focuses on providing a **comprehensive view of each parameter**. It visually highlights the key parameters. Choosing and selecting from lists and a saved profiles library now simplify exam management. This leads to an easier, clearer and more precise programming in less time.



Graphical user interface will be available in English once Accutron® CT-D Vision is commercially available.

## OPTIMIZED INTEGRATION INTO THE RADIOLOGY ENVIRONMENT

The Accutron® CT-D Vision is equipped with several substantial new features that optimize its integration into the radiology environment.

### Injection Data Sharing

Providing a RIS/PACS interface based on the DICOM standard, the new IDS software option offers direct access to the modality worklist from the RIS for the operator to associate each contrast injection results with the related patient images and data and save it in the PACS. Currently exporting these injection data as a secondary capture or as an ePDF, IDS is a flexible solution able to offer customized access to shared injection data.

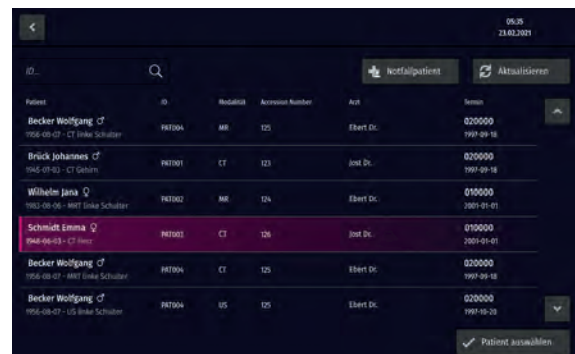

Graphical user interface will be available in English once Accutron® CT-D Vision is commercially available.



## BETTER INJECTOR MOBILITY

The wireless injector Accutron® CT-D Vision benefits from our recently launched Intelligent Battery Management System to optimize the duration of the battery charge and further increase the working availability. With the new medical grade casters the injector can be moved with less effort and quieter on imaging room floors.

## IMPROVED READABILITY IN THE CONSOLE ROOM

Inside the exam room, the choice of the light mode display on the injector screen enhances the readability of key parameters. In the low light of the console room, the operator can choose the dark mode display to reduce visual disturbances and allow the focus on the imaging procedure.



Graphical user interface will be available in English once Accutron® CT-D Vision is commercially available.

## EXTENDED TRACKABILITY TO PUNCTURE SITE DATA AND CONTRAST MEDIA TYPE



Graphical user interface will be available in English once Accutron® CT-D Vision is commercially available.

Trackability of contrast administration does not only mean recording the contrast dose. It also involves the way the dose was administered. By recording the puncture site location and the size of IV catheter as well as the contrast media type directly as part of the injection data, Accutron® CT-D Vision provides comprehensive trackability and documentation of contrast administration.

## DAY SAFE SYSTEM THE IDEAL COMPLEMENT

MEDTRON AG not only improves the performance of its injectors, but also works to provide even better disposables. The Day Safe System is a new complete system for 24h multiple use in CT and MRI.

Please contact your local dealer for further information.



**Accutron® CT-D  
VISION**





## Clinical Gains

- New user interface simplifies programming through selection from lists. Improved readability helps to avoid errors in injection settings. In addition, the monitoring of the injection is improved.
- Increases patient safety by reducing the amount of contrast a patient receives during the injection.
- Can reduce the risk of infection, as it is easy to clean and hygienic.
- Injection Data Sharing (optional) with data on the puncture site and recording of the contrast medium type offers comprehensive traceability and documentation of the contrast medium administration related to imaging, patient and study data (and makes this available digitally via the PACS)
- Supports women's health as first and so far only dual piston injector with extended purpose: contrast-enhanced mammography.



## Operating Gains

- More comfortable user interface improves overall usability.
- Intelligent battery management system and new casters improve mobility
- Integration with the scanner interface unburdens the operator and reduces the patient turnaround time.
- Direct integration with RIS and PACS enables the exchange of injection data as well as complete tracking and analysis of the contrast medium administration in CT.
- Wireless and mobile configuration offers flexibility for quick change of examination rooms and does not require a power supply during the examination.



## Financial Gains

- Can reduce contrast medium consumption per patient, resulting in lower operating costs.
- Supports the development of a new clinical application area in mammography, leading to potentially increased revenue.

# Accutron® CT-D Vision

## The New Diagnostic Specialist

The Accutron® CT-D Vision is designed for the precisely dosed injection of contrast medium (CM) and saline solution (NaCl) in computed tomography. It features an injection unit with two independently controllable drive units, so that the contrast medium can be positioned variably and precisely in the examination area with the aid of saline solution, depending on the application.

The Accutron® CT-D Vision is also designed for use in contrast-enhanced mammography.

### Easy Filling

Automatic filling or manual filling with variable speed

---

Filling speed: 1 – 5 ml/s

---

Optimized tube systems with check valves

### Wireless & Mobile

Mains supply independent thanks to high-output rechargeable batteries

---

Input voltage charger: 100 – 240 V, 50 – 60 Hz

---

Power consumption charger < 100 VA

### Mindful Workflow

Two-step launching process and Pre-inject function controlled via the start/stop hand switch provide precise monitoring

---

SMART Assist offers an automated workflow

### Hygienic Design

Tough, stable and light aluminum casing

---

Easy to clean and hygienic

---

Total weight: 26 kg





## Disposable

recommendations

### Single Use

Artikelnummer

2 x ELS 200 ml Syringe	316026-000
1 x MR-ELS Tube System with 2 Valves, green	317104-000
2 x Vented Spike	319095-100

### Multiple Use up to 8h

2 x ELS 200 ml MU Syringe	314626-100
1 x Double Head 8h Tube System	314119-100
1 x Vented Spike	314095-100
1 x Coiled Patient Line with Valve 150 cm	318214-000

### Multiple Use up to 24h

2 x Day Safe Syringe 200 ml	312426-100
1 x Day Safe Filling Tube Type D	312400-100
1 x SURE Patient Line	318415-100
2 x Vented Spike	314095-100

**Injection Volume:**

**max 200 ml** per piston  
1-200 ml, programmable  
in 1 ml increments

**Number of Phases:**

**1 to 6** phases

**Injection Pressure:**

**max 21 bar**,  
5-21 bar, programmable  
in 1 bar increments

**Flow Rate:**

**0.1 - 10 ml/s**,  
programmable in  
0.1 ml/s increments

**Injection Profiles:**

**80 profiles**,  
can be edited and  
stored by the user

**Injection, Phase  
and Scan Delay:**

**0 - 255 s**

**Filling Speed:**

**1 - 5 ml/s**,  
programmable in  
1 ml/s increments

**Keep Vein Open:**

**1 ml** every 2 minutes

Subject to technical alterations

# Specifications

highlighted

## Additional Highlights and Options



Remote Touch Screen  
FB866



Select Scanner  
Interfaces available



Hand  
Switch



Pre-filled  
Syringe Adapter



Gantry Version  
Model CT861-2



..... Battery Version Model CT860

..... Ceiling Mount Model CT861-1

..... Power Supply Version Model CT862



cli



# nical Application

## Cardiac CTA

Accutron® CT-D offers multiple phase capacities as well as the possibility for direct adjustment of contrast concentration with saline. This allows you to perform the popular tri-phasic protocol which consists of 3 phases i.e., pure contrast, diluted contrast and saline only flush.

This insures that the optimal contrast volume is in the left chambers and the coronary arteries when needed.

## CE Mammography

Accutron® CT-D is also now approved for the intravenous injection of contrast media when performing contrast-enhanced mammography.

Accutron® CT-D helps you to really focus on patient care by allowing for the testing of IV access with Pre-Inject, hand-switch injection launch with precise control and shorter reaction times in case an urgent stop is required.

## Pelvic & Lower Limb

When screening the lower part of the body, it is advantageous to place the injector behind the CT gantry, connected to the arms of the patient placed above their head.

Accutron® CT & CT-D's wireless mobility allows easy placement, wherever needed. And the touch screen on the injector allows you to check and adjust the injection protocol according to the patient's clinical conditions.

## CT Angiography

Using the Accutron® CT-D double head injector with multiple phase protocols allows you to optimize the delivery of contrast for vascular dynamic studies.

It also allows flushing the arterial supply with saline when focusing on organ tissue enhancement, or increasing the duration of the contrast peak for larger vessel studies.

# Accutron® CT





## Clinical Gains

- Provides real-time pressure monitoring which allows for improved precision and safety
- Integrated heatable syringe holder keeps contrast media heated to body temperature providing optimal viscosity and decreased patient discomfort



## Operating Gains

- Agile mobility with a configuration that provides flexibility to quickly change examination rooms
- Functions with select pre-filled syringes to increase throughput via quick use and improved patient turnaround times



## Financial Gains

- Consistent reliability helps to reduce repeat examinations due to contrast mistiming
- Provides solid performance and price affordability in CT imaging

# Accutron<sup>®</sup> CT

The Mobile Precision Partner

Model CT871

The Accutron<sup>®</sup> CT is a single head / single syringe power injector designed and built using the same technology platform that all Accutron<sup>®</sup> injectors are based upon. Whether you are budget conscious or newly exploring the potential use of a powered injector in your CT department, Accutron<sup>®</sup> CT is your starter model.

The Accutron<sup>®</sup> CT is designed for precisely dosed injections of contrast medium for computed tomography. The touch screen offers an overview at all times of the injection currently under way with the specified parameters. By means of the remote control you can control the high-pressure injector from the control room.

## Easy Filling

Automatic filling or manual filling with variable speed

---

Filling speed: 1 – 5 ml/s

---

Optimized tube systems with check valves

## Mindful Workflow

Up to 80 injection profiles, individually created for your examination and easily accessible

---

Two step launching process controlled via the start/stop hand switch provides precise monitoring.

## Agile Mobility

Continuous operation with power supply unit

---

Input voltage charger  
100 – 240 V AC, 50 – 60 Hz

---

Low weight and compact design allows easy placement.

---

Wireless touch screen remote control offers cable-free installation and service.

## Hygienic Design

Tough, stable and light aluminum casing

---

Easy to clean and hygienic

---

Total weight: 14 kg





## Disposable

recommendations

### Single Use

Article number

1 x ELS 200 ml Syringe	316026-000
1 x Patient Line with Valve 150 cm	318152-100
1 x Vented Spike	319095-100

---

### Multiple Use

1 x ELS 200 ml MU syringe	314626-100
1 x Single Head 8h Tube System	314081-100
1 x Vented Spike	314095-100
1 x Coiled Patient Line with Valve 150cm	318214-000

**Injection Volume:**  
max 200 ml

**Number of Phases:**  
1 to 6 phases

**Injection Pressure:**  
max 21 bar,  
5-21 bar, programmable  
in 1 bar increments

**Flow Rate:**  
0.1 - 10 ml/s,  
programmable in  
0.1 ml/s increments,  
optional selection of  
flow rate or phase duration

**Partial Injection  
Volume:**  
1 - 200 ml,  
programmable in  
1 ml increments

**Injection Profiles:**  
80 profiles,  
can be edited and  
stored by the user

**Injection, Phase  
and Scan Delay:**  
1 - 255 s

**Filling Speed:**  
1 - 5 ml/s,  
programmable  
in 1 ml/s increments

Subject to technical alterations

# — Specifications

highlighted

## Additional Highlights & Options



Single head heated  
receptacle



Pre-filled  
Syringe adapter

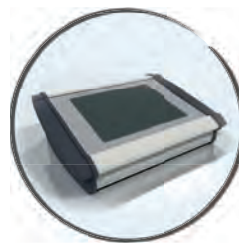

Remote  
Touch Screen



Hand  
Switch

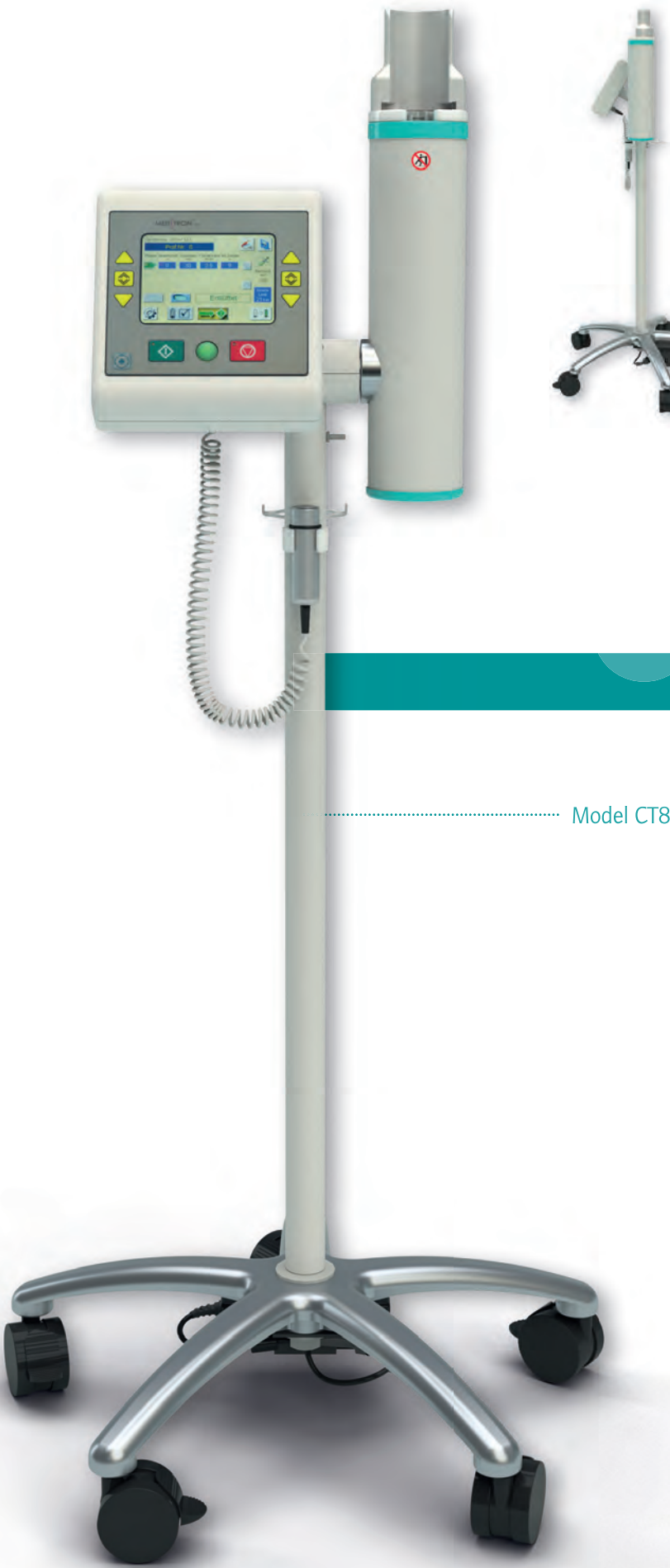

Model CT871

# Pre-Inject

## Minimize Contrast Extravasation

Extravasation remains a well known adverse effect with the use of intravenous injection and iodinated contrast media during MDCT procedures. Studies report that 0.3% to 0.7% of patients could experience an extravasation event.

Using the Pre-Inject feature with the Accutron® CT-D and CT series allows the radiographer to conduct a test injection to insure IV patency so as to minimize contrast media extravasation.





## Software Option

Once activated in the injector settings, the built-in Pre-Inject function will propose to perform a test injection before each contrast protocol.



## Test Injection

The test injection is performed with saline at the maximum programmed flow rate. The test injection helps validate the patency of the IV access and to evaluate the comfort of the patient with the injection.



## User Activated

Managed with injection handle while hand monitoring the patient's arm. The injector moves to "Activate injector" status automatically after Pre-Inject.



## Override Option

Even if Pre-Inject is activated in settings, the test phase can be skipped easily so as not to impede your workflow. With override, the injector then goes to "Activate injector" status with the programmed protocol.

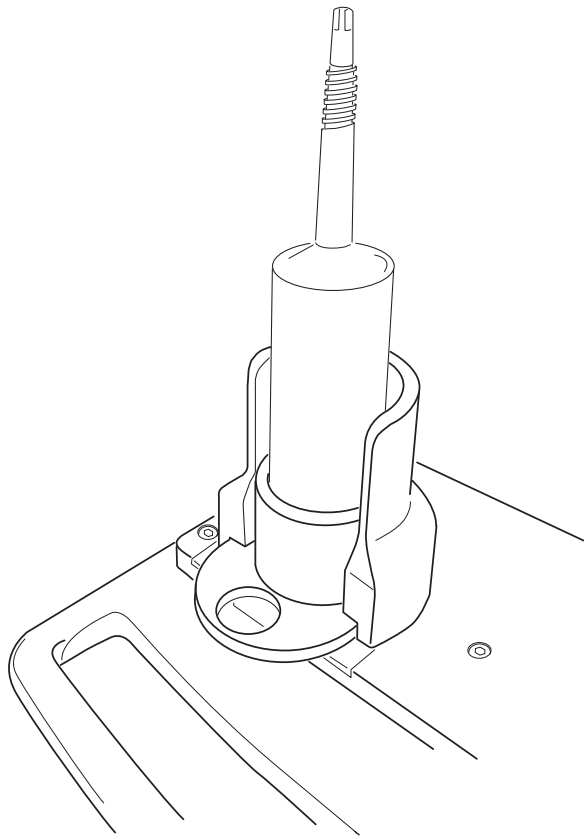

## Works with Select Pre-filled Syringes

For quick use and faster patient turnaround times. The adapter and software are optimized for Optiject pre-filled syringes. Direct selection of syringe size under injection parameters. Available sizes range from 75 ml up to 125 ml.

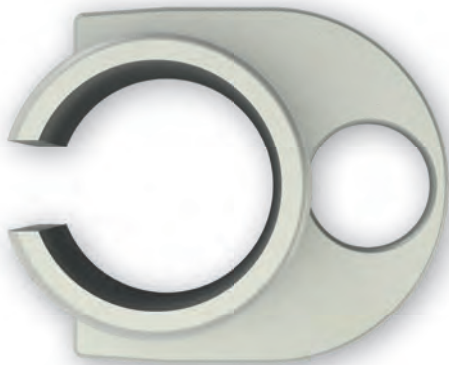



# Easy Loading Syringe (ELS)

**200  
ml**

Crystal clear  
syringes

**Slide  
turn**

Slide and turn  
to install

**Fixed  
luer**

Half turn to  
easily connect  
line's hubs

**Quick  
remove**

Removable in any  
position of  
the piston

# Multi-Use

## Disposables

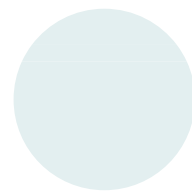

### 1 Exchangeable Spike

Protects from multiple spiking thereby reducing contamination risks

### 5 Multiple Use Syringes

Multiple use syringes are certified to insure they prevent air carried contamination

### 2 Multiple Use Filling System

Protects syringes and vials from retrograde contamination and allows multiple refill and injections

### 6 Prevents Crystallization

In-line drip chamber with filter prevents crystallized contrast particles from passing into syringe and tubing system

### 3 Specialized Y-Connectors

Precision engineered Y-connectors reduce swirling and air bubbles

### 4 Safe Valves

Safe valves on tubing and patient line provide optimal protection from cross contamination

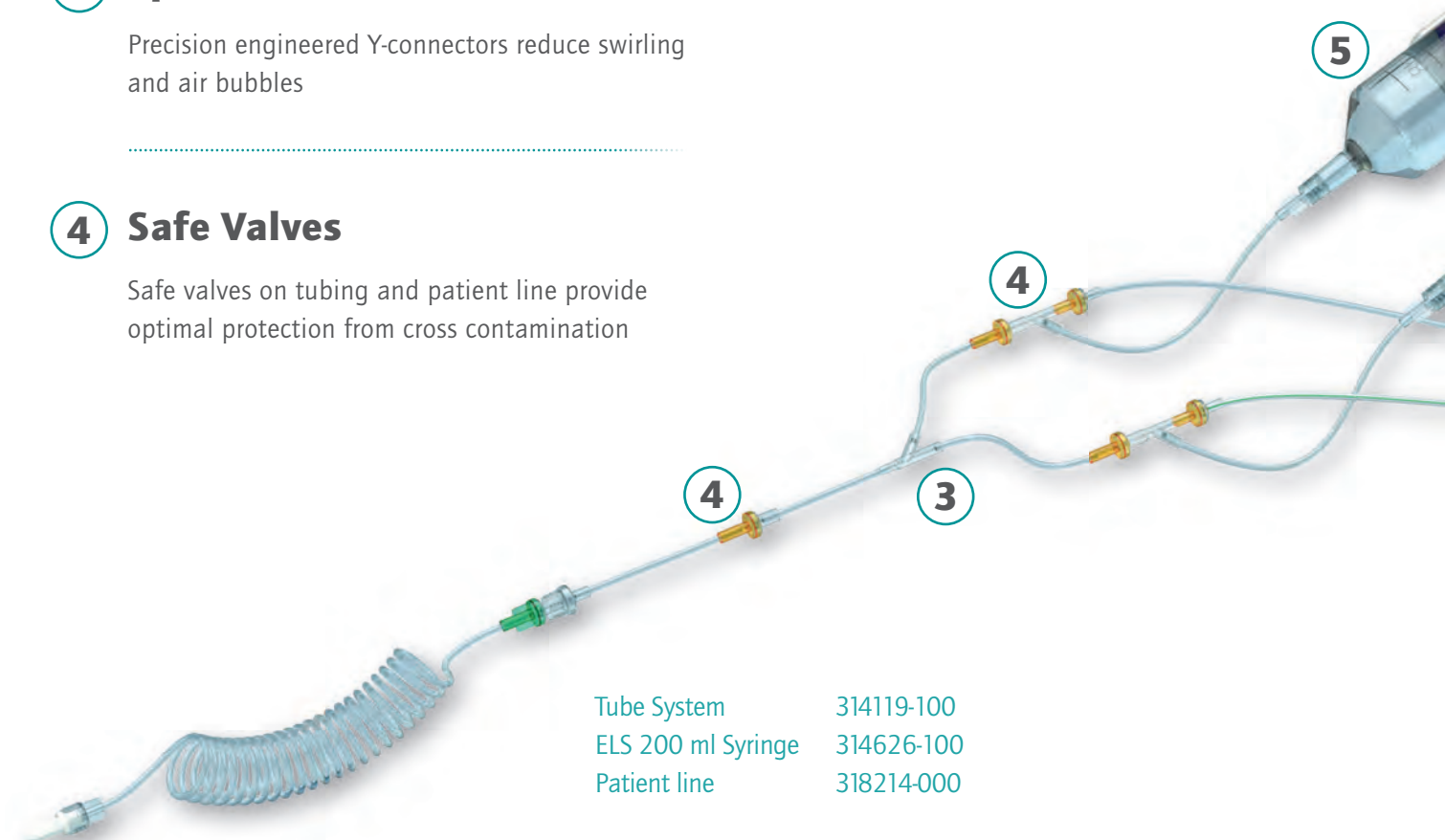

Tube System	314119-100
ELS 200 ml Syringe	314626-100
Patient line	318214-000

Picture shows multiple use consumables for up to 8h.

Detailed information on our new Day Safe System (usable up to 24h) is available on [medtron.com](http://medtron.com).





2

1

6

# Intelligent

## Battery Management System

MEDTRON AG has designed a completely new intelligent Battery Management System to prevent damage through over-/undercharging so as to prolong the life of your injector battery. It features a combined power supply and charger in one device and

allows the end user to utilize the injector and charge at the same time, if so required. The Intelligent Battery Management System is a new feature and currently only available on select Accutron® Injectors. Check with your sales partner for further information.

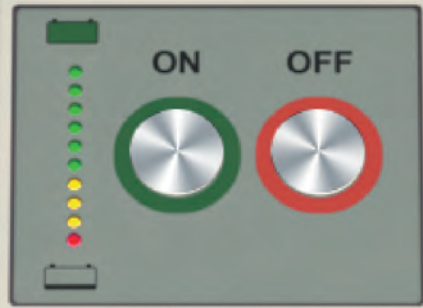



## Operating Gains

- The combined power supply & charger in one device requires less user intervention and simplifies your recharging workflow
- Being able to use the injector and charge at the same time helps to optimize your workflow and enhance your flexibility.
- The resistance to damage from liquid spillage is increased due to an enhanced piston isolation, and the relocation of the hand switch and charger plug as well as the use of liquid proof Piezo type on/off buttons.
- A holder is placed at the bottom of the injector to keep the power supply unit off the floor.
- Our new LED display shows actual capacity during usage and during charging. It also indicates the charging process with running lights to provide more insight about the injector's operational capacity in any state.



## Clinical Gains

- Being easy to clean the holder for the power supply unit is a hygienic solution which may help to reduce the risk of infections.



## Financial Gains

- Preventing under-/overcharging, the intelligent Battery Management System efficiently maintains the battery reducing frequent battery changes and replacement costs.
- The holder prevents damage from moisture and grime by keeping the charger/power supply unit away from the floor; thus helping to mitigate replacement costs

MEDTRON AG is a global medical technology company and a leading European manufacturer of state-of-the-art contrast medium injectors.

**MEDTRON AG**

**Give us a call or write to us!**

**Team DACH:**

Germany, Austria, Switzerland

Tel.: +49 (0)681-97017-72

Fax: +49 (0)681-97017-60

sales.dach@medtron.com

**Team International 1:**

W/S-EMEA, LATAM, Africa, APAC

Tel.: +49 (0)681-97017-26

Fax: +49 (0)681-97017-20

sales.int1@medtron.com

**Team International 2:**

E-Europe, CIS

Tel.: +49 (0)681-97017-63

Fax: +49 (0)681-97017-20

sales.int2@medtron.com

**Service:**

Tel.: +49 (0)681-97017-83

Fax: +49 (0)681-97017-85

service@medtron.com



**MEDTRON AG | Hauptstrasse 255 | 66128 Saarbruecken, Germany**

Tel: +49 (0)681-97017-0 | Fax: +49 (0)681-97017-20 | info@medtron.com

Visit us online at [www.medtron.com](http://www.medtron.com)