

# Ino



## Reclining armchair \

This comfortable reclining armchair was developed specifically as a universal design recliner that evolves with the needs and desires of its user. Because of its modular structure, the reclining armchair can even be converted from a 'design version' to a full 'care version'.

The Ino does not only have a light modern look, it actually is a very light chair. The chair's sleek design gives it a sense of sophistication while also ensuring a high level of stability. The Ino is very manoeuvrable and very maintenance-friendly too.

Our collection of contemporary fabrics adds a personal touch to the chair and ensures that it fits perfectly in your interior. The numerous available options and accessories include a tray attachment and coffee table. All in all, it is a unique product! Experience it for yourself!

## What makes the Ino Relax so unique? \

- \ \ Very comfortable
- \ \ Ergonomic operation
- \ \ Large 'care' handles
- \ \ User-friendly
- \ \ Maintenance-friendly
- \ \ Modular design – can be adjusted at any time
- \ \ Manoeuvrability and mobility – intended to move
- \ \ Different seating heights
- \ \ Manual head support adjustment integrated as standard
- \ \ Extreme stability and strength
- \ \ Hoist accessible (active, passive & return hoist)
- \ \ Optionally available as sleeping armchair



WATCH OUR INO  
PRODUCT VIDEOS!  
CLICK HERE OR SCAN THE  
QR CODE!



Subject to change without notice, latest update 2021-11, images shown are for illustration purposes only

# OVERVIEW OF INO RELAX



## Armrests

Available with 9 different armrests, both open and closed and in different types of materials.

More information on page 5

## Adjustment mechanism

4 different adjustment mechanisms are possible, both manual and electric. The Zero Gravity version is available with a relaxing position and also a sleeping position.

More information on pages 3 and 4

## Frame & castors

Available with 5 different types of base, depending on the frame, castor size and braking method.

More information on page 7

## Options & accessories

The Ino Relax has a whole list of options and accessories to adapt the Relax to the user's needs.

More information on page 9

Subject to change without notice, latest update 2021-11, images shown are for illustration purposes only

# RECLINING MECHANISMS

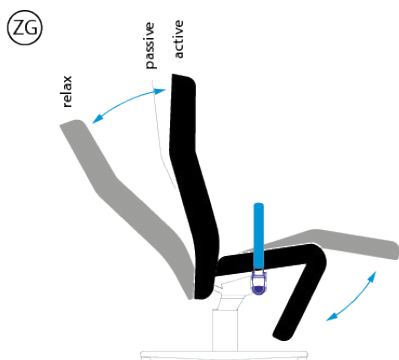

**ZERO GRAVITY 130°**

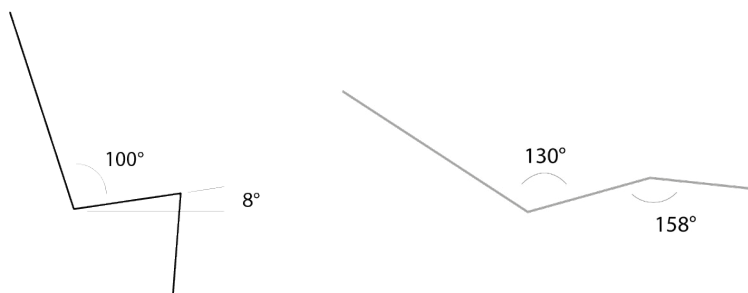

Pure simplicity. The back and leg rest are synchronously steplessly adjustable. From an active or passive sitting posture to an excellent relaxing position. The maximum angle between the back and the seat is 130° in the relaxing position.

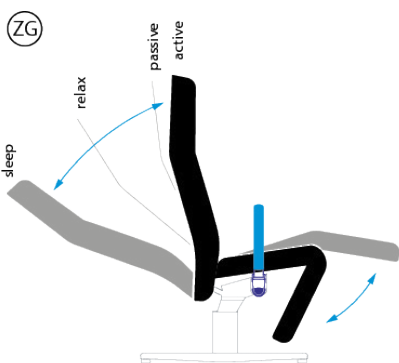

**ZERO GRAVITY 140°**

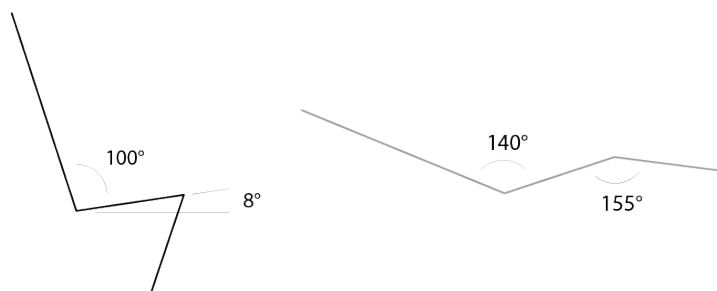

Pure simplicity. The back and leg rest are synchronously steplessly adjustable. From an active or passive sitting posture to an excellent relaxing or sleeping position. The maximum angle between the back and the seat is 140° in the sleeping position.

Subject to change without notice, latest update 2021-11, images shown are for illustration purposes only

# RECLINING MECHANISMS

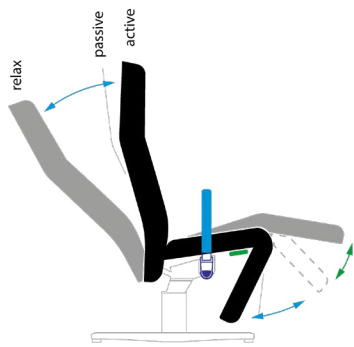

**DUO COMFORT  
SYNCHRO 130°**

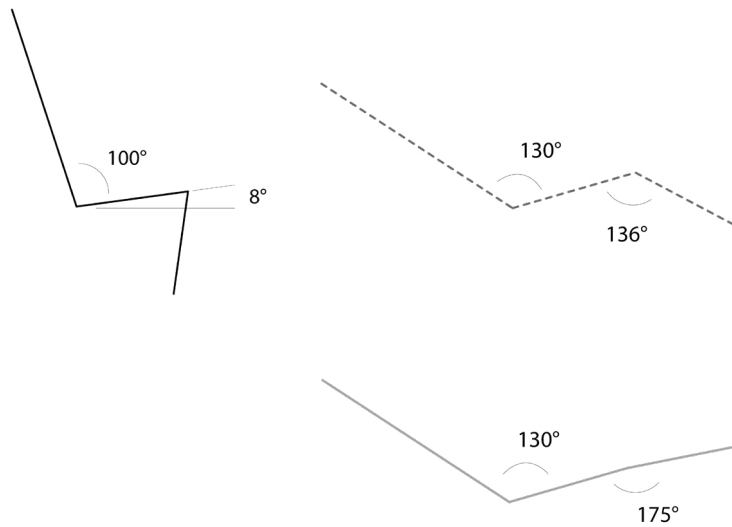

Ergonomics. Duo Comfort Synchro offers numerous sitting and lying positions. The back and leg rest are synchronously and steplessly adjustable by means of a gas spring. From an active and passive sitting posture to an excellent relaxing position. The maximum angle between the back and the seat is 130° in the relaxing position.

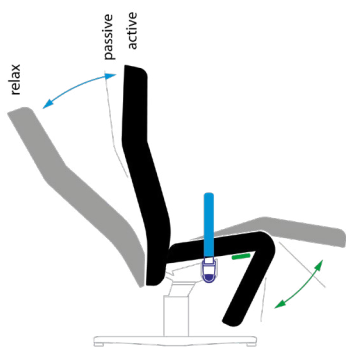

**DUO COMFORT  
SOLO 130°**

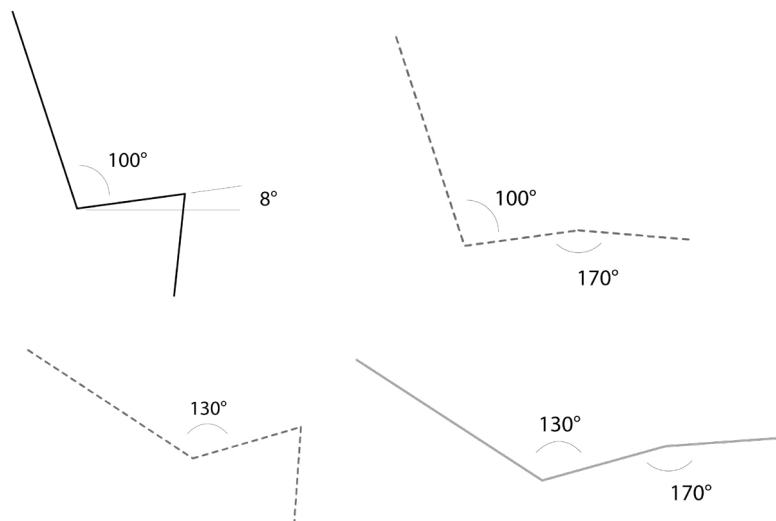

Easy to use. Seat, back and leg rest are individually steplessly adjustable by means of 2 gas springs. From an active and passive sitting posture to an excellent relaxing position. The maximum angle between the back and the seat is 130° in the relaxing position.

Subject to change without notice, latest update 2021-11, images shown are for illustration purposes only

## RECLINING MECHANISMS

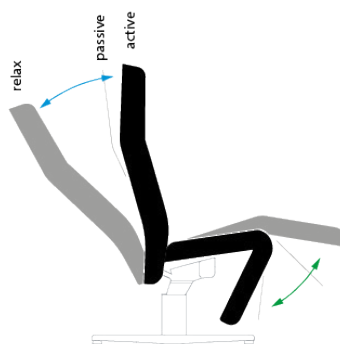

**ELECTRICAL 125°**

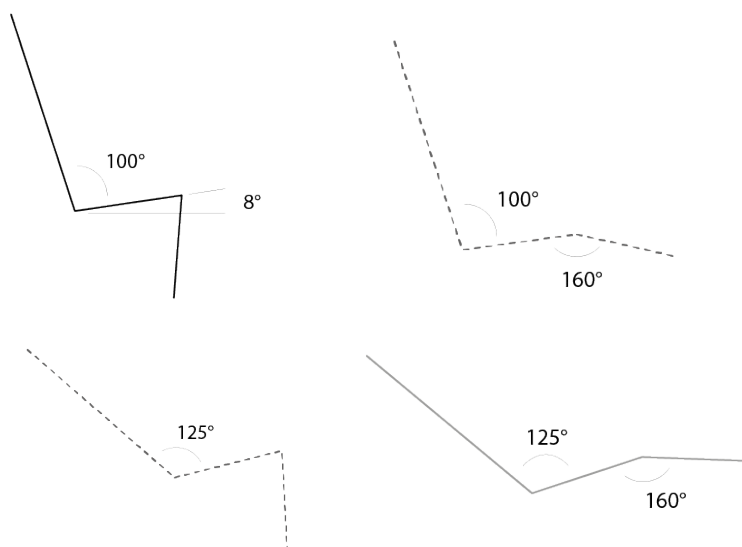

Easy to use. Seat, back and leg rest can be adjusted electrically. 2 motors: 1 for the operation of the back, 1 for the operation of the leg rest. Back and leg rest can be operated together or separately.

The maximum angle between the back and the seat is 125° in the relaxing position.

Possibility of removable and rechargeable battery.

Subject to change without notice, latest update 2021-11, images shown are for illustration purposes only

## ARMRESTS

The Ino Relax can be fitted with various armrests, ranging from comfortable fully upholstered armrests to slide away armrests. Depending on the type, it may also be possible to attach a tray to the armrest.



## FRAME & CASTORS

Aluminium star base with aluminium column, epoxy-coated. All versions with  $\varnothing$  125 mm castors are provided with an ergonomically-shaped plastic push bar and a foot support. The following versions are possible:

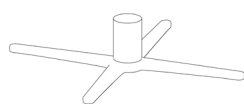

Fixed, not manoeuvrable

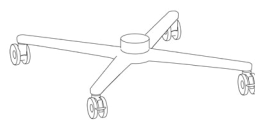

Castors  $\varnothing$ 75

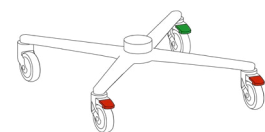

Castors  $\varnothing$ 125

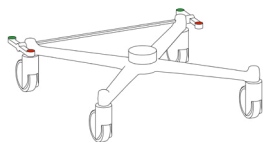

Castors  $\varnothing$ 125 central brake, at the rear

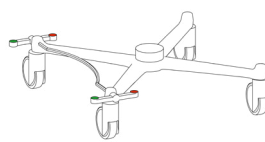



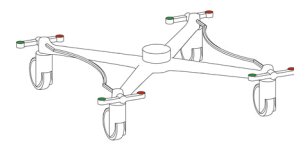







Castors  $\varnothing$ 125 central brake, at the sides (left, right or both sides)



Subject to change without notice, latest update 2021-11, images shown are for illustration purposes only

# TECHNICAL FEATURES

## DIMENSIONS

TYPE											
Ino	69-83	74-86	119-125	50	46	46-56	81	65-74	35-40	yes	★ ★ ★

★ = domestic use / ★ ★ = project-based use / ★ ★ ★ = intensive project-based use

### (\*) Seat height

Each Ino reclining armchair is available in 4 seating heights: 46 – 48 – 50 and 52 cm. The Ino reclining armchair with castors Ø75 and Ø125 mm are also available with seat height 54 and 56 cm. The length of the leg support is determined by the seat height. The seating heights can be adjusted easily with the modular design of the Ino.

### (\*\*) Seat width

Measured between the armrests and the seat: front 50 cm – rear 48 cm

### Armrest height

21 cm – measured from the seat

## SEAT, BACK AND LEG REST

Upholstered. Ergonomically shaped.

Particularly comfortable chair thanks to combination of elastic webbing over a steel tube frame and complete foam padding. The high-density foam which is injected is fire retardant.

The underside of the seat is finished with an elastic, moisture-repellent and washable material as standard. Every chair has a manually adjustable head support as standard.

With the integrated leg rest there are no annoying edges and openings between the seat and leg rest. Functionally designed minimum opening between the seat and back for easy cleaning.

Version with Ø 125 mm castors is provided with an ergonomically-shaped plastic push bar as standard.

## OPTIONS AND ACCESSOIRES

There are a number of options and accessories available for the Ino, including a tray, serum holder and coffee table,... Take a look at our technical data sheets and brochure to see all possibilities.

Subject to change without notice, latest update 2021-11, images shown are for illustration purposes only

## USE

Ino Zero Gravity and Ino Duo Comfort each have 2 ergonomically formed plastic control handles. The recliner is simply operated by moving these handles forwards (push) or backwards (pull), this will release the gas spring and enables you to smoothly switch to the desired sitting or lying position. It is possible to lock the reclining armchair in any sitting or lying position of your choice, or to have the reclining armchair move freely.

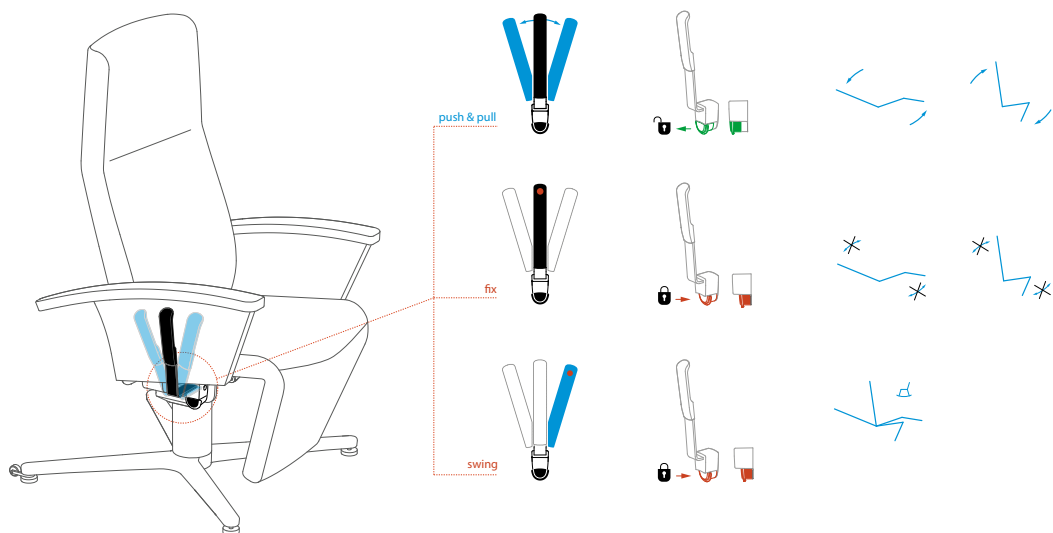

The Ino Electric has a permanent battery as standard (via cable feed). The Ino can be easily placed in the desired sitting or sleeping positions via the simple manual control. There is also the option of working with a removable and rechargeable battery to gain greater freedom of movement within the room.

Subject to change without notice, latest update 2021-11, images shown are for illustration purposes only



## OVERVIEW OF MODELS



INO CASA FIXED



INO CASA CASTORS Ø 75



INO CASA CASTORS Ø 125



INO CASA CASTORS Ø 125  
CENTRAL BRAKE



INO LIGNA FIXED



INO LIGNA CASTORS Ø 75



INO LIGNA CASTORS Ø 125



INO LIGNA CASTORS Ø 125  
CENTRAL BRAKE



INO CURA FIXED



INO CURA CASTORS Ø 75



INO CURA CASTORS Ø 125



INO CURA CASTORS Ø 125  
CENTRAL BRAKE

Subject to change without notice, latest update 2021-11, images shown are for illustration purposes only

## OVERVIEW OF MODELS



INO CURA NS FIXED



INO CURA NS  
CASTORS Ø 75



INO CURA NS  
CASTORS Ø 125



INO CURA NS  
CASTORS Ø 125  
CENTRAL BRAKE

---

Subject to change without notice, latest update 2021-11, images shown are for illustration purposes only