



500 XLE

TREATMENT CHAIR



E

2024 V03

ENJOY QUALITY AND DESIGN

500 XLE

Item No.: 1500 0006

The perfect reclining treatment chair for rotation systems in outpatient operating rooms.

**Powerful
and agile**



MED.TEC at its highest level

Double castors

Four fully rotating double-run castors for back-friendly, easy rolling motion.



Chassis/frame

Precision steel frame chassis, zinc primed with anthracite textured paint coating.

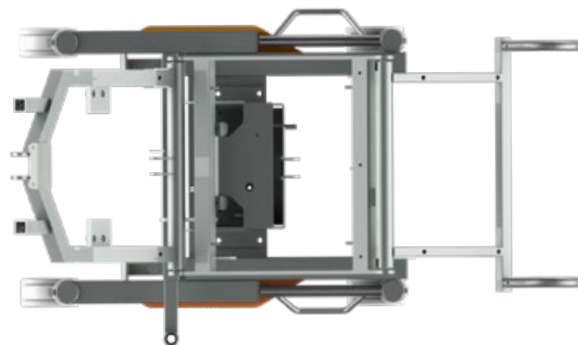

Chassis cover/upholstery

The mirror-finish plastic cover panels with their scratch-resistant and impact-modified surface finish are extremely hygienic and easy to disinfect.

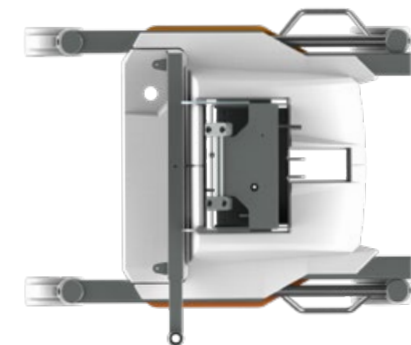

Precise positioning of the head part

Headrest

3D and longitudinally adjustable headrest element with head molding and neck support for guaranteed safe and correct head positioning.

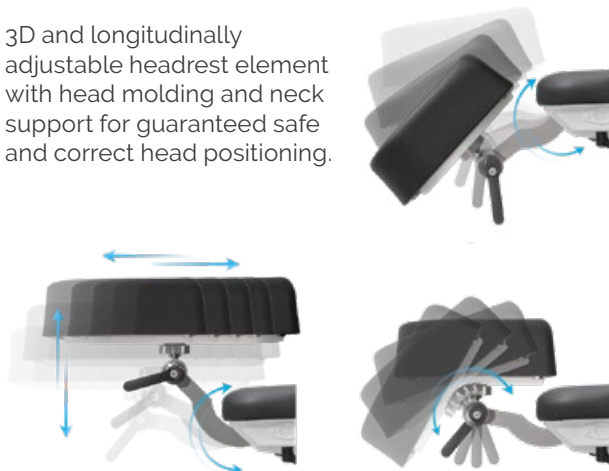

Components

Headrest with ball joint and more

Discover additional features and extensive components on page 34.

Item No.: 3351 1021



Sterile adjustment by surgeon/maximum legroom

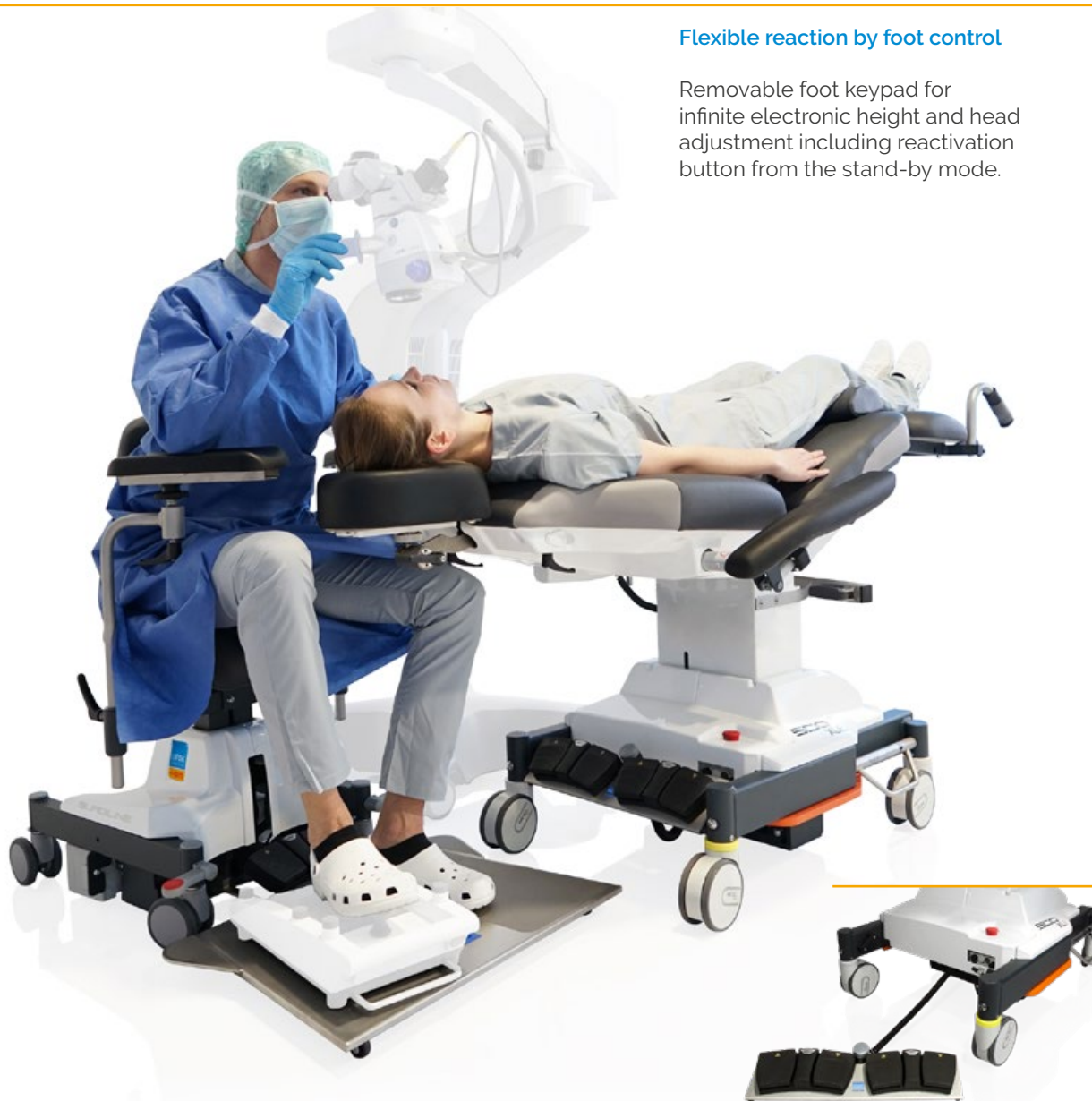

Flexible reaction by foot control

Removable foot keypad for infinite electronic height and head adjustment including reactivation button from the stand-by mode.

Positioning



The 500 XLE treatment chair is designed for ergonomic and comfortable patient positioning and treatment, particularly for outpatient surgical techniques. It offers versatile adjustment of the head, back, seat and leg sections and overall chair height for patient transport.

- Eight freely programmable memory positions
- CPR button
- Reset button
- Auto run function
- Battery charge indicator



Hand control

Multi-functional manual keypad

Battery charge indicator

Reset button

CPR button

AUTO Auto run function

MEMORY 8 free configurable memory positions

Positioning by hand control

Standard recommended memo keys



Mechanical maneuvering aid on the chassis



Operation via foot lever on the chassis

Activation of directional guidance

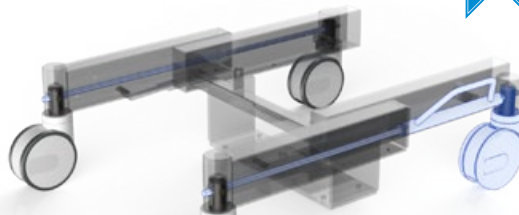

Pushing from the head direction

Pushing from the foot direction

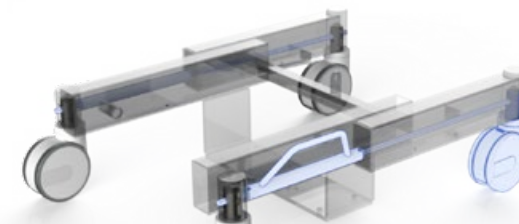

Braking system

Manually adjustable foot lever

Castors are braked

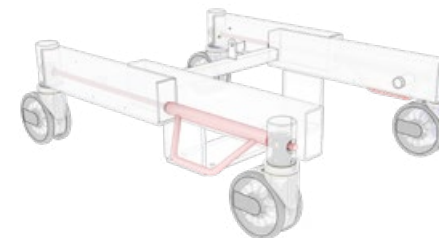

Castors are released, directional guidance is deactivated

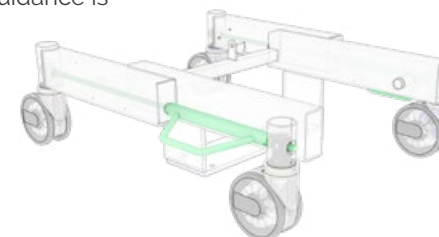

Push handles

Detachable push handles on the foot ends for easy maneuvering.



Armrests

Hinged and removeable armrests for easy entry and exit as well as transfer of the patient.



Components

Additional handles/shoulder parts and more

Discover additional features and extensive components on page 34.



500 XLE comfort

Item No.: 1500 0006
+ 3037 0080

Our 500 XLE with extra thick upholstery, integrated knee support cushion and flattened neck area - for extra reclining comfort.

**Outstanding comfort,
particular flexibility.**



Upholstery

Comfort

Thick comfort upholstery and integrated knee support cushion, individually positionable to suit every patient's body height. The treatment chair featuring comfort upholstery is particularly well suited for longer surgical procedures (e.g. retina surgery).



Available in a wide variety of colors. Please refer to page 94 for our complete range of colors.



Flexibility in every detail

Headrest

The flattened back cushion of the Comfort upholstery in the neck area offers maximum freedom of movement for the headrest.



Components

Integrated knee support cushion

Optimum patient comfort thanks to the integrated knee support cushion which can be easily adjusted to accommodate any patient height.



An optional legrest extension can be attached when treating tall or very tall patients.



Foot part extension

Adjustable foot part extension incl. foot support for easier entry and exit of the patient. See page 34.



Besides, entry height is reduced by 80 mm.

Item No.: 3351 1028



190 mm

Technical specifications



PERFORMANCE
LINE

Chassis

- Frame profile 90 x 50 mm
- Outside length 785 mm
- Outside width incl. lever 720 mm
- Steel tube frame, powder-coated elegant anthracite matte finish
- Brake operable from both sides and acting on two castors each; two castors featuring independent directional steering function
- Double rimmed castors \varnothing 125 mm
- Detachable foot keypad (total, head up/down)
- Emergency stop button
- Visible screws are made of stainless steel
- With equipotential bonding connection

Upper frame

- 4-part support frame (head, back, seat, leg part)
 - Removeable upholstery
 - Width of upholstery 610 mm
 - Width incl. armrests 850 mm
 - Length 1.760 – 1.900 mm
(incl. legrest extension) + 190 mm
- | | Angle | Dimensions (L x W) |
|---------------------|----------------------------|---|
| • Head part | -29°/+35° | 255 x 245 mm |
| • Back part | 0°/+83° | 610 x 610 mm |
| • Seat part | -5°/+35° | 450 x 610 mm |
| • Leg part | 0°/-77° | 510 x 610 mm |
| • Height adjustment | | 625 – 925 mm
(comfort) 655 – 955 mm
(2x) 470 x 75 mm |
| • Armrests | 0°/+180° | |
| • Entry height | | (standard) 580 mm/500 mm (incl. legrest extension)
(comfort) 610 mm/530 mm (incl. legrest extension) |
| • Legroom | | 520 – 820 mm |
| • Trendelenburg | -12°/Reverse Trendelenburg | +5° |

Electrical control

- All components according to IP54
- Hand control with 8 individually programmable memory positions, auto run function, reset button
- Foot keypad with 4 foot switches and reactivation button

Electric Drives

- Head, back, seat, leg part, total up/down
- Trendelenburg/Reverse Trendelenburg

Lifting column

- Max. lifting 300 mm
- Max. load 250 kg
- Motors IP54 with HAL sensors, to be memorized

Trendelenburg/Reverse Trendelenburg/CPR



Back part/leg part

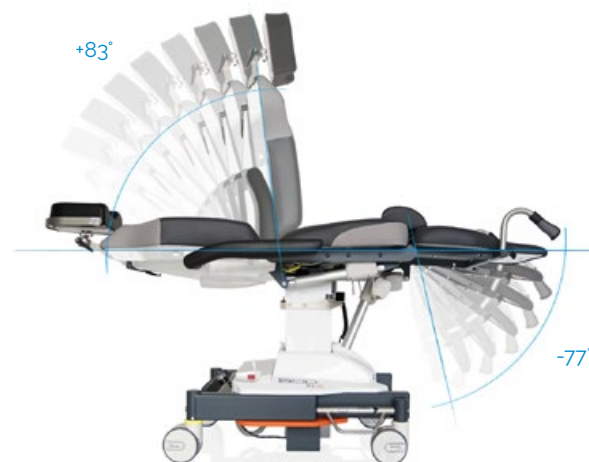

Height adjustment

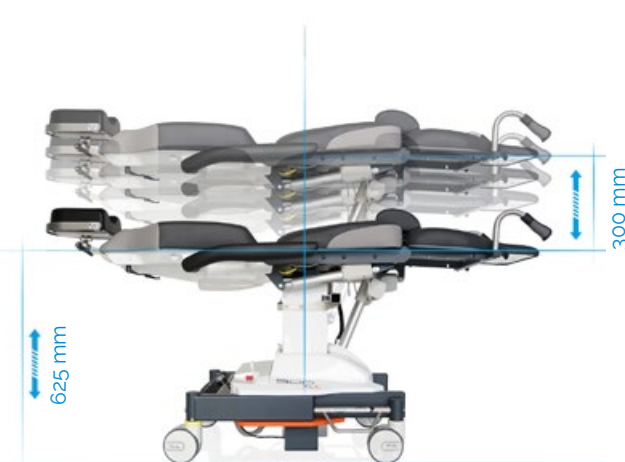

Components



500 XLE

Item No.: 1500 0006



500 XLE comfort

Comfort upholstery incl. integrated knee roll, upcharge

Item No.: 1500 0006 + 3037 0080



Side parts right and left, swiveling incl. locking, upholstered, 580x200 mm

Item No.: 3351 0012



Norm rail seat part

Item No.: 3351 0047



Side parts right and left, 580x200 mm, incl. quick-release clamp for mounting on norm rail (norm rail 3351 0047 not included)

Item No.: 3351 0050



Pushing handles back part, pair

Item No.: 3351 0046



Pushing handles back part, pair

Item No.: 3351 0017



Anesthesia arm board with universal joint, with arm secure straps

Item No.: 3351 0011



Flexible surgical drape support rod

Item No.: 3205 0000



Flexible surgical drape support rod with air connection

Item No.: 3206 0000



Hand control holder, PVC (component holder 3351 0037 not included)

Item No.: 3351 1023



Hand control holder for attachment onto an I.V. Pole Ø 25/18 mm, PVC

Item No.: 3351 1022

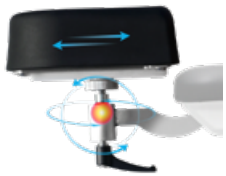

Headrest with ball joint, 360° all-round adjustment, factory-fitted

Item No.: 3351 1021



Backup battery

Item No.: 3047 0000



Head part bumper stainless steel

Item No.: 3028 0000



Wrist rest, adjustable, incl. mounting plate 3013 0000, adjustment 115 mm

Item No.: 3014 0000



Wrist rest, adjustable, tiltable, incl. mounting plate 3013 0000, adjustment 115 mm

Item No.: 3014 0005



Mounting plate stainless steel, for wrist rest 3014 0000 and 3014 0005

Item No.: 3013 0000

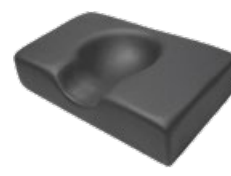

Head fixation pillow with hollow (rubins pillow), 410x250 mm, height 100 mm, factory-fitted

Item No.: 3022 0000



Facial pillow, horseshoe-shaped, incl. adapter plate, factory-fitted

Item No.: 3351 1016

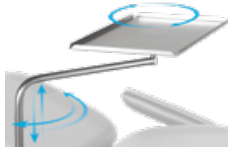

Instrument table 500x300x15 mm, height adjustable, swiveling, detachable, incl. adapter (component holder 3351 0037 not included)

Item No.: 3065 0000



Shoulder parts right and left 500 **XLE**
Item No.: 3071 0000

500 **XLE** comfort
Item No.: 3071 0001



Knee half roll, 600x280x140 mm, PUD-coated

Item No.: 3019 0000



Knee roll round, 500x150 mm, PUD-coated

Item No.: 3050 0000

Medical device



Instrument table *supportLine* height adjustable 730–1,000 mm

Item No.: 3351 0026

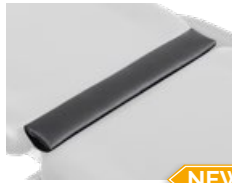

NEW

500 **XLE**
Trapeze cushion, wedge, for back/seat part

Item No.: 3351 1052

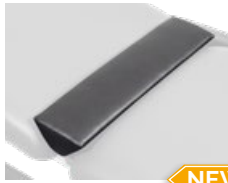

NEW

500 **XLE** comfort
Trapeze cushion, wedge, for back/seat part

Item No.: 3022 0005



Wrist secure straps, pair

Item No.: 3015 0000



Body strap with Velcro straps, 2-piece

Item No.: 3083 0000



Foot part extension incl. foot support, factory-fitted, upcharge

Item No.: 3351 1028



Foot protection foil

Item No.: 3092 0001



IV. Pole stainless steel Ø 25/18 mm, one-hand height adjustable 1,070–1,660 mm, 4 hooks, max. 2 kg/hook, glass and holder (component holder 3351 0037 not included)

Item No.: 3068 0000

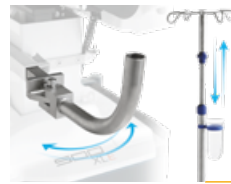

Component arm stainless steel, swiveling, incl. extendible IV. Pole Ø 25 mm

Item No.: 3024 0014



Component holder, stainless steel

Item No.: 3351 0037



Cylinder holder

Item No.: 3072 0002

Color cards



Customize the upholstery of your products to color-coordinate them with your workplace environment.



To do this, select one or two colors (main and accent color - as with the 500 **XLE** *comfort* and 500 **ECO**) from one of the following color cards.



Application example *motionLine-E*

The colors displayed on your device may differ slightly from the original colors. If you wish to receive original color charts, please contact us at info@ufsk-osys.com.

Example: standard version

-  **Main color:**
anthrazit F6461197
Item No.: 3037 0052
-  **Accent color:**
chrom F6461205
Item No.: 3037 0056





500 XLE comfort

Item No.: 1500 0006
+ 3037 0080



Examples of color combinations

-  schoko F6461357
Item No.: 3037 0060
-  feuer F6461454
Item No.: 3037 0063



-  safran F6461542
Item No.: 3037 0069
-  schoko F6461357
Item No.: 3037 0060



-  atoll F6461453
Item No.: 3037 0062
-  weiß F6461198
Item No.: 3037 0134



Color card
skai® Tundra



High quality skai® material with fine calf leather grain and subdued matte-gloss-effect. The very extensive and trend-orientated color spectrum enables many applications and combinations.

Product Specification

- Long-lasting
- Tear resistant
- Easy to clean
- Abrasion resistant (DIN EN ISO 6570-2)
- Lightfast
- Disinfectant resistant
- Biocompatibility: cytotoxicity (EN ISO 10 993-5) and epicutaneous test (EN ISO 10 993-10)
- Blood- and urine resistant
- Phthalate-free
- Vegan

<i>eyeForce</i>		1800 0000
<i>500 XLE</i>		1500 0006
<i>500 XLE comfort</i>		1500 0006
		+ 3037 0080
<i>500 XLS</i>		1500 0005
<i>500 ECO</i>		1500 0008
<i>400 XL</i>		1400 0001
<i>surgiForce</i>	Formed seat	2600 0008
<i>surgiForce light</i>	Formed seat	2600 0009
<i>surgiLine</i>	Formed seat	2200 0008
<i>assistLine</i>		2400 0015
<i>motionLine</i>		1700 0000
<i>motionLine-E</i>		1700 0001

+ Item No.: 3037 0...

weiß F6461198 Item No.:134	creme F6461210 Item No.:057	beige F6461636 Item No.:094	sand F6461230 Item No.:058	pistazio F6461610 Item No.:153	mint F6461495 Item No.:067	aqua F6461456 Item No.:001	türkis F6461338 Item No.:008
perle F6461288 Item No.:007	silber F6461550 Item No.:070	stone F6461608 Item No.:075	bleu F6461496 Item No.:068	dolphin F6461609 Item No.:076	sky F6461581 Item No.:073	royal F6461196 Item No.:051	atoll F6461453 Item No.:062
violett F6461356 Item No.:059	cyclame F6461381 Item No.:119	orchidee F6461354 Item No.:011	bordeaux F6461350 Item No.:010	kirsche F6461199 Item No.:054	feuer F6461454 Item No.:063	karneol F6461557 Item No.:072	orange F6461556 Item No.:071
apricot F6461458 Item No.:066	mais F6461457 Item No.:065	mango F6461607 Item No.:074	safran F6461542 Item No.:069	limonade F6461343 Item No.:009	limone F6461543 Item No.:109	smaragd F6461455 Item No.:064	agave F6461273 Item No.:006
chrom F6461205 Item No.:056	ocean F6461204 Item No.:055	schoko F6461357 Item No.:060	schwarz F6461195 Item No.:050	anthrazit F6461197 Item No.:052			

The colors displayed on your device may differ slightly from the original colors. If you wish to receive original color charts, please contact us at info@ufsk-osys.com.

Color card

skai® Pandoria Plus



skai® Pandoria Plus is a high-quality upholstery material, whose fine micropore structure gives a certain unobtrusiveness, which is refined by an attractive tone-in-tone effect. The very pleasant feel of the material and the excellent material characteristic and the broad, modern color spectrum make skai® Pandoria Plus universally usable.

Product Specification

- Long-lasting
- Tear resistant
- Easy to clean
- Abrasion resistant (DIN EN ISO 5470-2)
- Resistant to oil and fat
- Lightfast
- Disinfectant resistant
- Flame protection
- Biocompatibility: cytotoxicity (EN ISO 10 993-5) and epicutaneous test (EN ISO 10 993-10)
- Resistant to sudor, blood and urine
- Antibacterial according to JIS Z 2801
- Vegan

<i>eyeForce</i>		1800 0000
<i>500 XLE</i>		1500 0006
<i>500 XLE comfort</i>		1500 0006
		+ 3037 0080
<i>500 XLS</i>		1500 0005
<i>500 ECO</i>		1500 0008
<i>400 XL</i>		1400 0001
<i>surgiForce</i>	Formed seat	2600 0008
<i>surgiForce light</i>	Formed seat	2600 0009
<i>surgiLine</i>	Formed seat	2200 0008
<i>assistLine</i>		2400 0015
<i>motionLine</i>		1700 0000
<i>motionLine-E</i>		1700 0001

+ Item No.: 3037 0136
 + Item No.: 3037 0...

weiß F6413046 Item No.:053	hellbeige F6413047 Item No.:141	kiesel F6413048 Item No.:158	birke F6413049 Item No.:159	smoke F6413050 Item No.:221
silbergrau F6413075 Item No.:275	platin F6413053 Item No.:161	anthrazit F6413076 Item No.:276	schwarz F6413052 Item No.:170	schoko F6413051 Item No.:160
gletscher F6413055 Item No.:162	sky F6413074 Item No.:277	royal F6413056 Item No.:163	smaragd F6413073 Item No.:278	kaktus F6413077 Item No.:281
feuer F6413058 Item No.:166	kirsche F6413079 Item No.:279	fuchsia F6413078 Item No.:280	mais F6413057 Item No.:164	limone F6413054 Item No.:165

The colors displayed on your device may differ slightly from the original color charts. If you wish to receive original color charts, please contact us at info@ufsk-osys.com.

Upgrade your OR to perfection.



eyeForce



500 XLE



500 XLE comfort



500 XLS



500 ECO



400 XL



motionLine



motionLine-E



surgiForce



surgiForce light



surgiTrend



surgiLine



stayClean



stayClean roll



stayClean kick bucket



stayClean collector



assistTrend



assistPro F



assistPro H



easyPro F



easyPro R



easyLine F



easyLine R



assistLine



supportLine

CONTACT US



UFSK
INTERNATIONAL

OSYS

UFSK-International OSYS GmbH
Kirchhoffstraße 1
93055 Regensburg
Germany

Tel. +49 (0) 941 78862 15
Fax +49 (0) 941 78862 35
E-Mail info@ufsk-osys.com
Web ufsk-osys.com

MADE IN GERMANY
Design | Construction | Manufacturing